

Chapter - 9

Peer To Peer Protocols

Peer-to-peer protocols

- A peer-to-peer protocol involves the interaction of two or more processes through the exchange of messages , called protocol data units(PDU).
- The purpose of this protocol is to provide a service the higher layer.

Service models

- It describes the services provided by the protocol.
- There are 2 broad categories of service models.
 1. Connection Oriented
 2. Connectionless

Connection oriented services

- The phases of connection oriented services are

Connection establishment

Data transfer

Connection termination

Example - TCP protocol

Connectionless service

- Individual blocks of information are transmitted and delivered based on the destination address provided.
- This service does not provide acknowledgement for transmitted information.

E-x Internet protocol, User Datagram Protocol(UDP)

The services provided by a given layer have the following

- Arbitrary message size
- Sequencing
- Reliability
- Timing
- Flow control
- Multiplexing
- Authentication

features

The settings in peer-to-peer protocols

- Single Hop
- End-to-End

Single Hop

- It uses physical and data link layer of the OSI model.
- The packets from network layer arrives at the data link layer.
- The data link layer encapsulates the packets into frames.
- Frames are transmitted to physical layer and converted into individual bits and these bits are converted into signals.

End-to-End

- End-to-End transmission is best explained with respect to process-to-process delivery provided by transport layer.
- In this layer ,the data movement is known by segments.

The responsibilities of data link layer

- Flow control

Flow control refers to a set of procedures used to restrict the amount of data that the sender can send before waiting for acknowledgment.

- Error control

Error control is both error detection and error correction.

In the data link layer, the term error

ARQ(Automatic Repeat Request) protocols

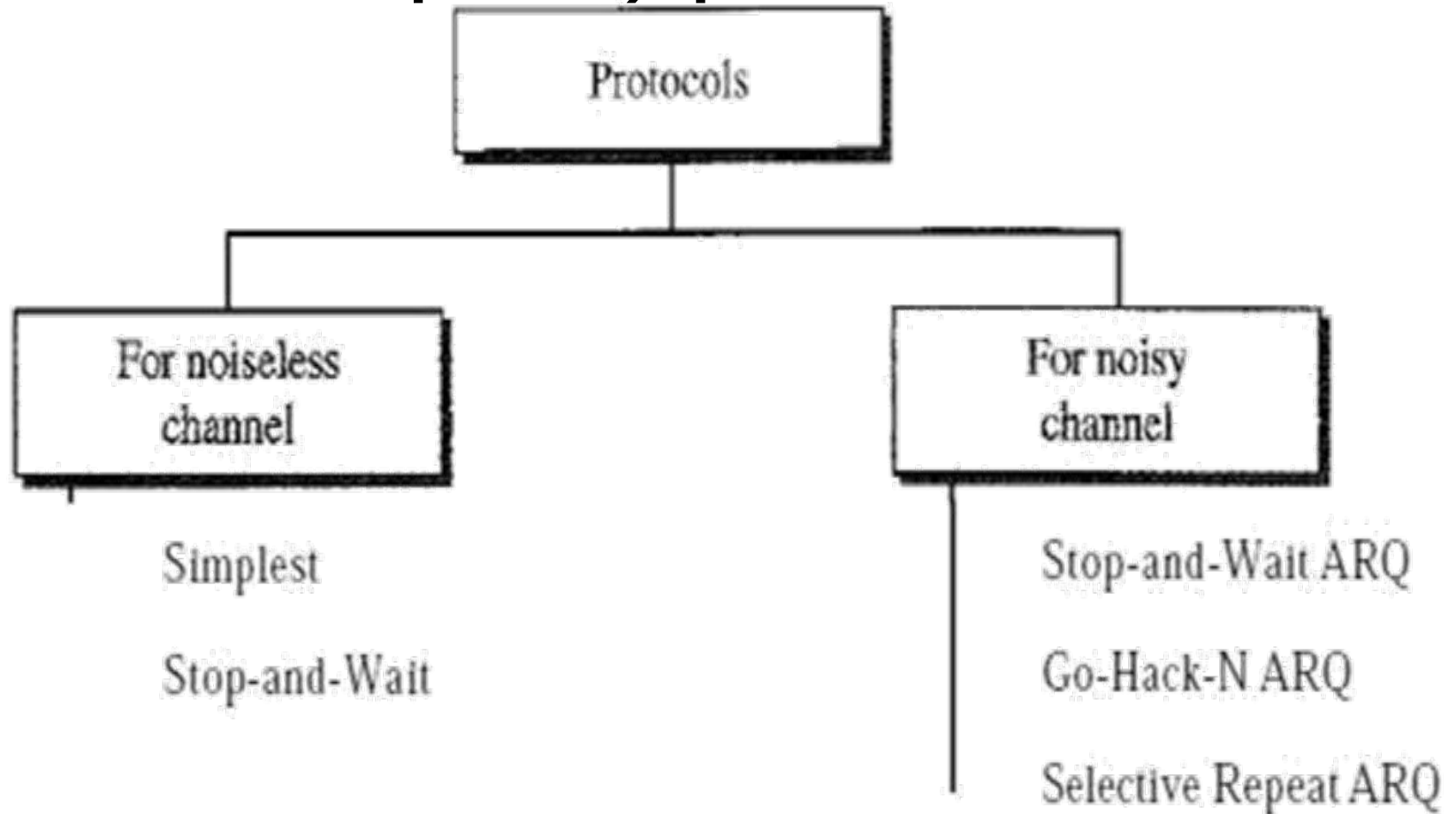

ARQ (Automatic Repeat Request) Protocols

- Automatic repeat request (ARQ) is a protocol for error control in data transmission. When the receiver detects an error in a packet, it automatically requests the transmitter to resend the packet. This process is repeated until the packet is error free.
- ARQ protocols provide reliable data transfer service.
- ARQ combines error detection and

Basic elements of ARQ

- **ARQ Protocol**

It is the set of rules that made for transmitter and receiver.

- **Information frames**

It transfers the user packets.

- **Control frames**

It consists of a header that provides control information followed by CRC.

2. Error Control

LG Figure 5.8 Basic elements of ARQ

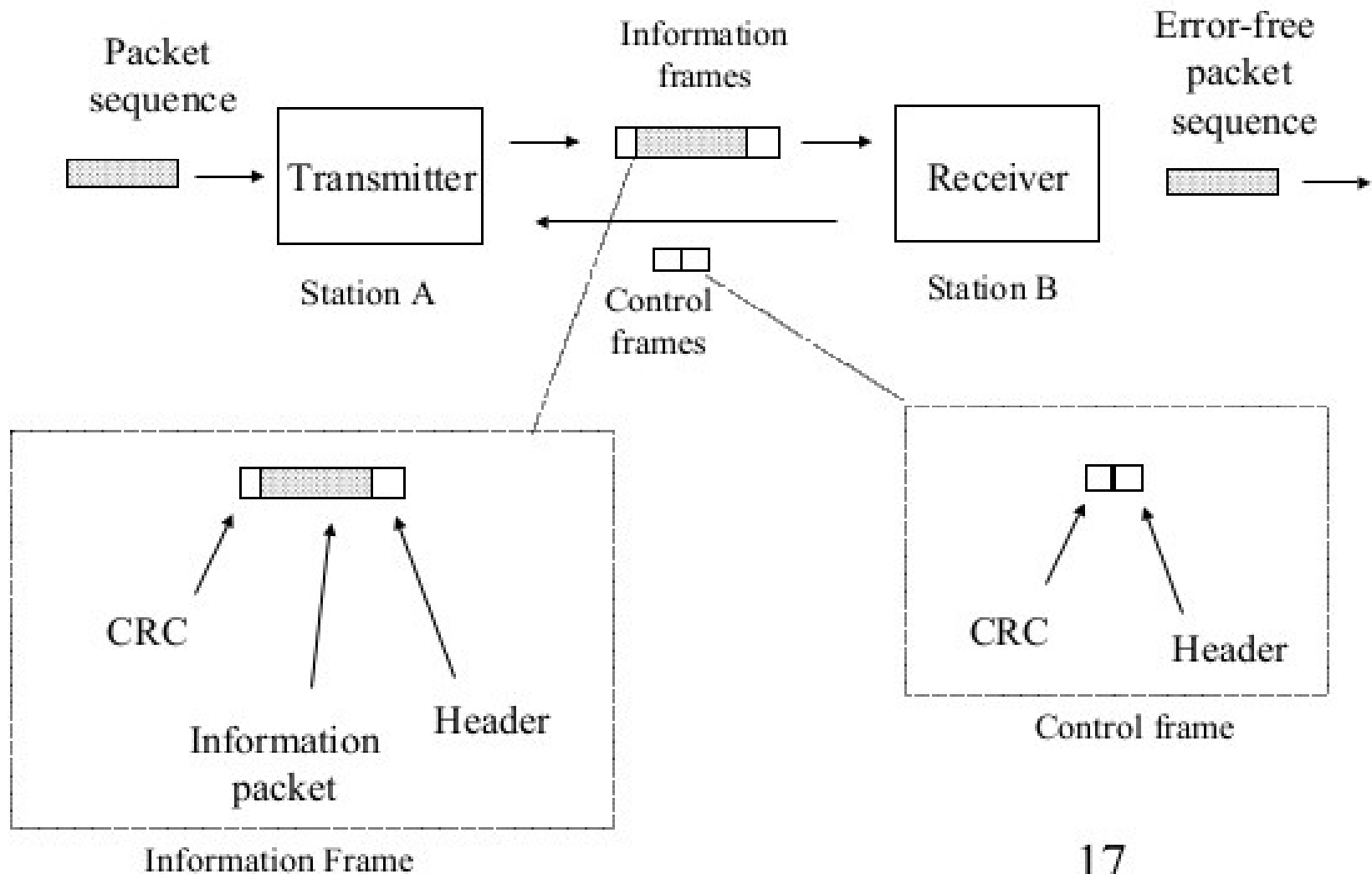

Stop-And-Wait ARQ

- The sender and receiver work on the delivery of one frame at a time.
- Sender sends an information frame to the receiver.
- The sender then stops and waits for the acknowledgement from the receiver.
- For identification, both data frames and acknowledgement frames are numbered.

Stop and wait ARQ – Normal operation

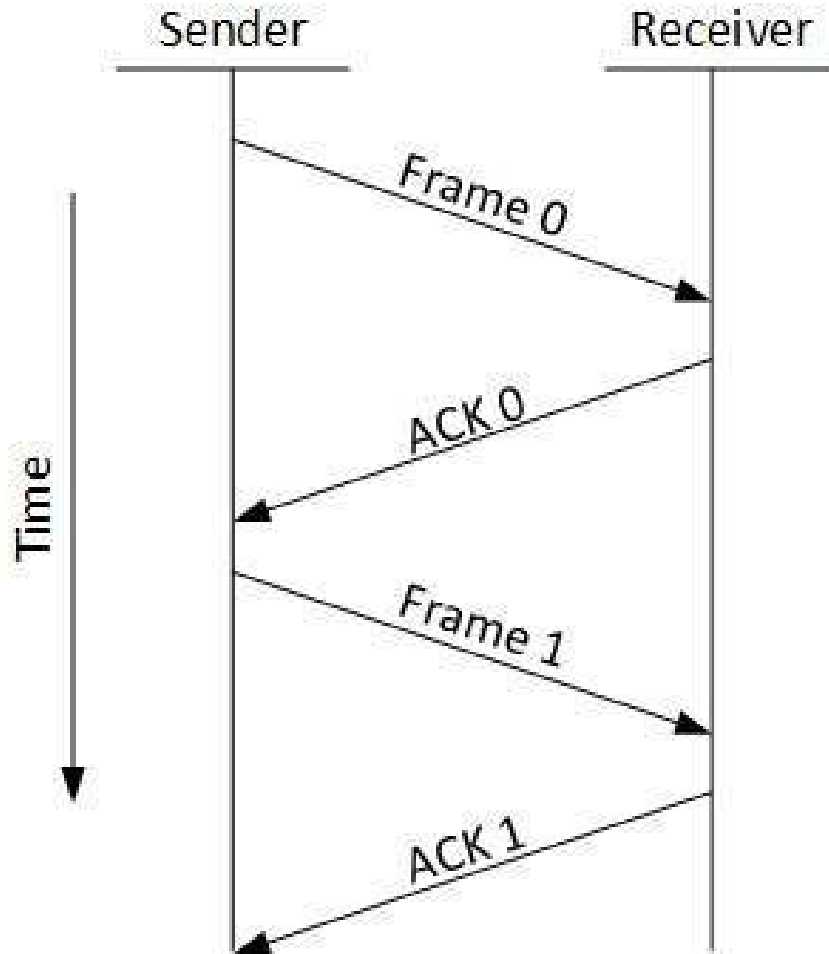

Stop and wait ARQ – Lost ACK frame

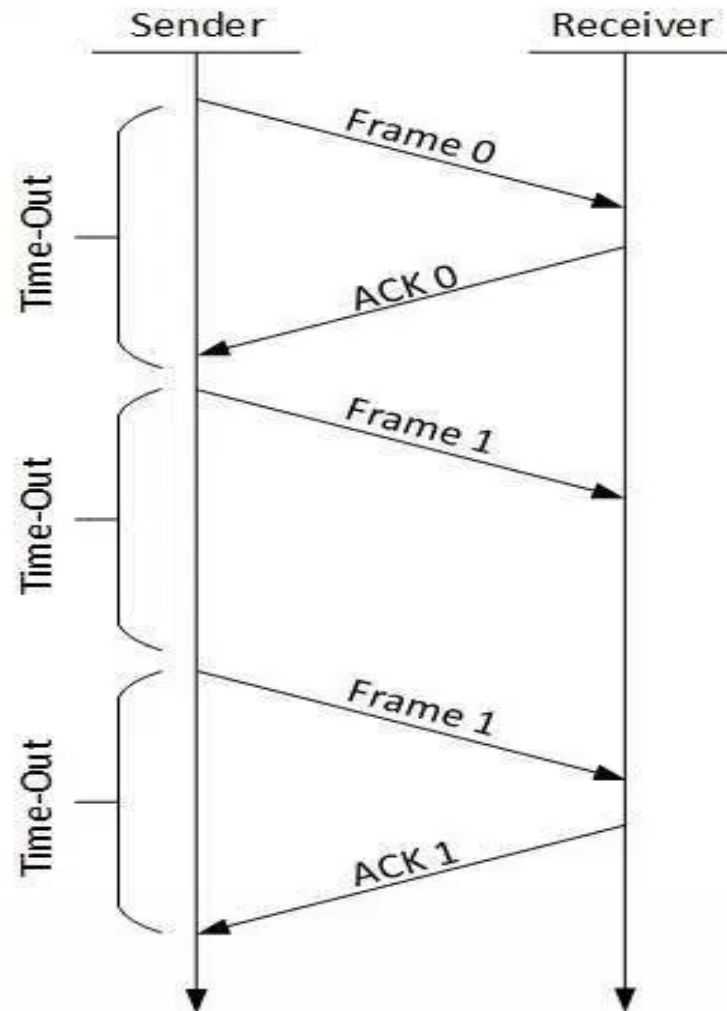

ERROR CONTROL

Stop-and-Wait ARQ, lost frame

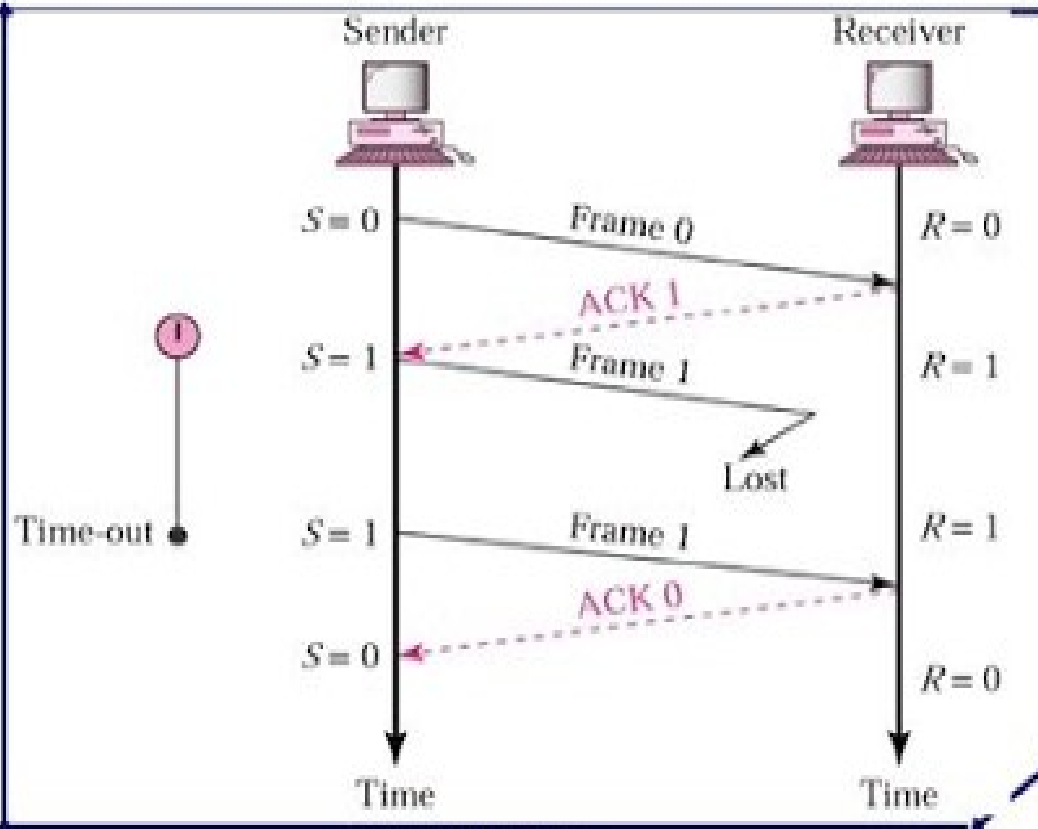

Go-Back-N-ARQ

- Go-Back-N ARQ overcome the inefficient transmission of stop and wait ARQ.
- Multiple frames are sent thru Go-Back-N-ARQ
- Frames from a sending station are numbered sequentially.
- If the header of the frame allows m bits for the sequence number, the sequence numbers range from 0 to $2^m - 1$.

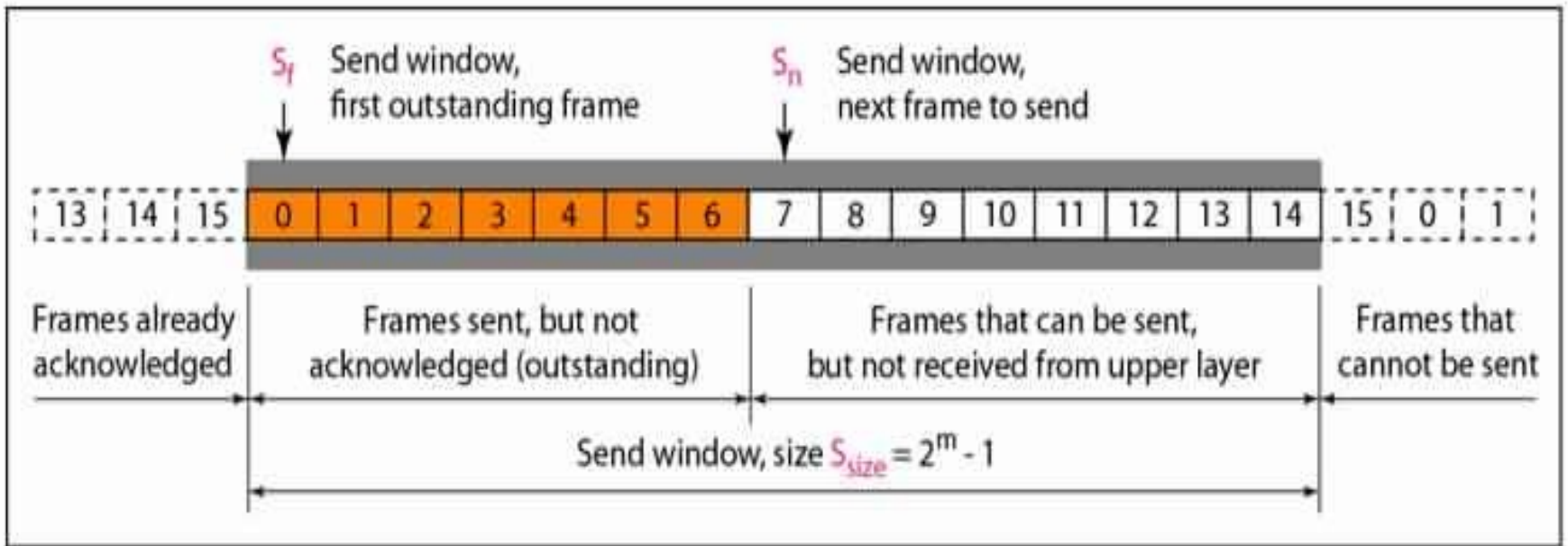

a. Send window before sliding

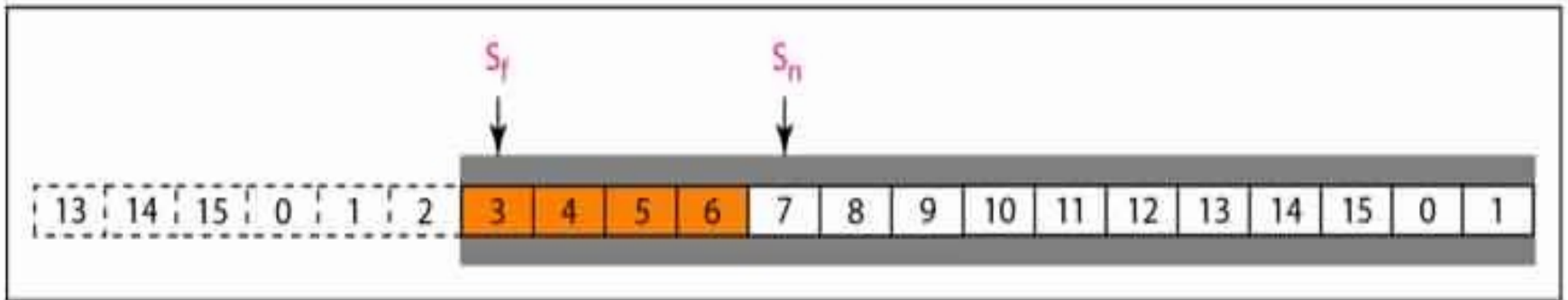

b. Send window after sliding

- **First region** – Defines the sequence no belonging to the frames that are already acknowledged.
- **Second region** – defines the sequence no belonging to the frames which are sent and waiting for acknowledgement.
- **Third region** – Defines the sequence no that can be sent further.
- **Fourth region** – Defines the sequence no that cannot be sent until window slides.

11.9 Go-Back-N ARQ, normal operation

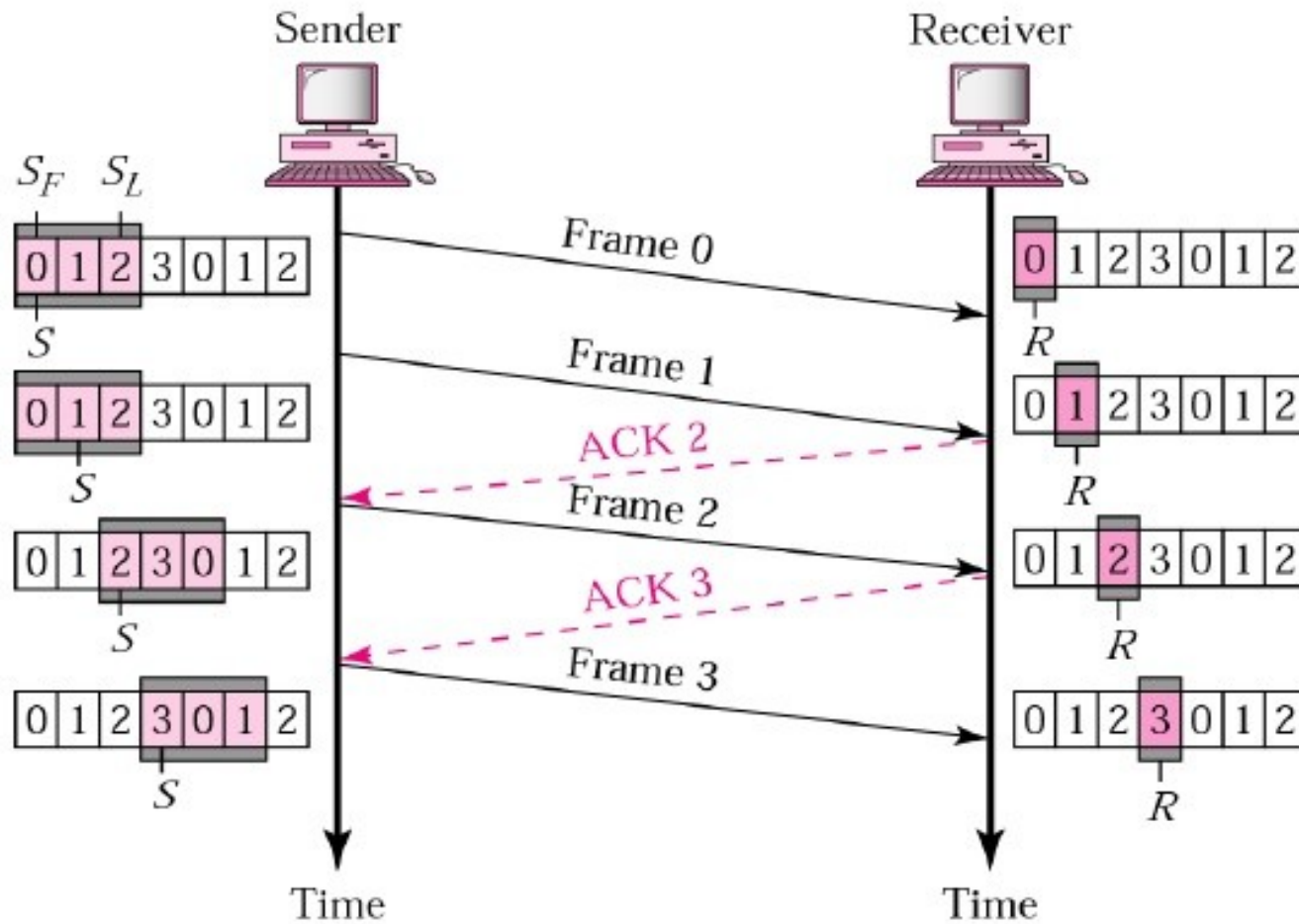

Selective Repeat

- In Go-Back-N ARQ ,If one frame is corrupted then all the other N frames were need to be resent.
- Instead of retransmitting n frames ,here only corrupted frames are retransmitted.
- This mechanism is called selective repeat.

Piggy backing

- A technique called piggybacking is used to improve the efficiency of bidirectional protocols. When a frame is carrying data from A to B, it can also carry control information (ACK frames) from A to B and B to A.
- Frame = data + ACK which increases the overall efficiency of transmission.

Bidirectional Transmission

- Data are transferred both ways
- ACK are "piggybacked" with data frames

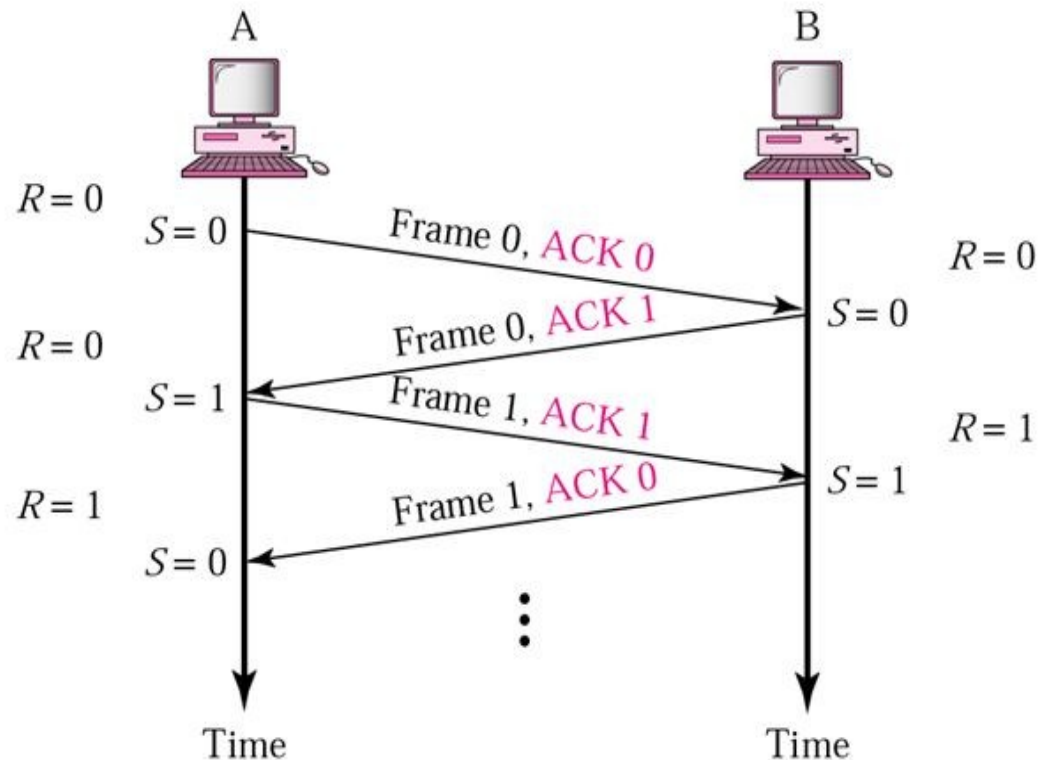

Other peer-to-peer protocols

- Sliding window flow control
- Timing recovery for synchronous services
- TCP Reliable stream service

Sliding window flow control

- When a sender can send information faster than the receiver can process it, messages can arrive at the receiver lost because buffers are unavailable.
- Flow control is a mechanism that prevents a sender from overrunning of receiver's buffer.
- Process A is sending data to process B at a rate of R bps. If process B detects that it's buffers are filling up, it sends a stop

Timing recovery for synchronous services

- To recover the original signal at receiver end, the information must be put into the decoder at the same rate at which it was produced at the encoder.
- For timing recovery, time stamps are inserted with each block that enters the network.
- At receiver side, an additional delay is calculated ,using the difference time stamps of the current block and preceding

TCP Reliable Stream service

- TCP protocol provides connection oriented reliable stream service.
- TCP protocol is responsible transmitting byte stream order without errors or duplications.

Functions of data link layer

- **Framing** : The bits that are transmitted needs to pack and transmit as frames and beginning and ending of frames should be defined.
- **Error control** : Data Link layer should provide error control to ensure reliable transmission.
- **Flow Control** : Data Link Layer should provide flow control to prevent the transmitter from overflow of sent frames.

The data link control

- Framing
- Point-to-point Protocol
- High level Data Link Control (HDLC)

Framing

- Framing involves identifying the beginning and ending of a block of information.
- Frames can be fixed or variable size.
- In fixed size framing, there is no need for defining the boundaries of the frames.
- In variable size framing, we have to define the end of the frame and beginning of the frame.

Two types of framing techniques

Byte stuffing

Special characters are added to identify the beginning and end of the frame

Bit Stuffing

Special bit patterns are added to identify the beginning and end of the frame

Byte stuffing

- One byte is added at the beginning and ending of the frame.
- Data to be sent

A B C D

DLE A STX DLE B STX DLE C STX DLE D
STX

BIT STUFFING

- Bits are added at the beginning and ending of the frame.

PPP (Point-to-Point) Protocol

- PPP is a protocol which is used for point-to-point connection.
- It is a byte-oriented protocol.
- It defines the format of the frame that has to be exchanged two devices.
- PPP was designed to support multiple network protocols simultaneously.

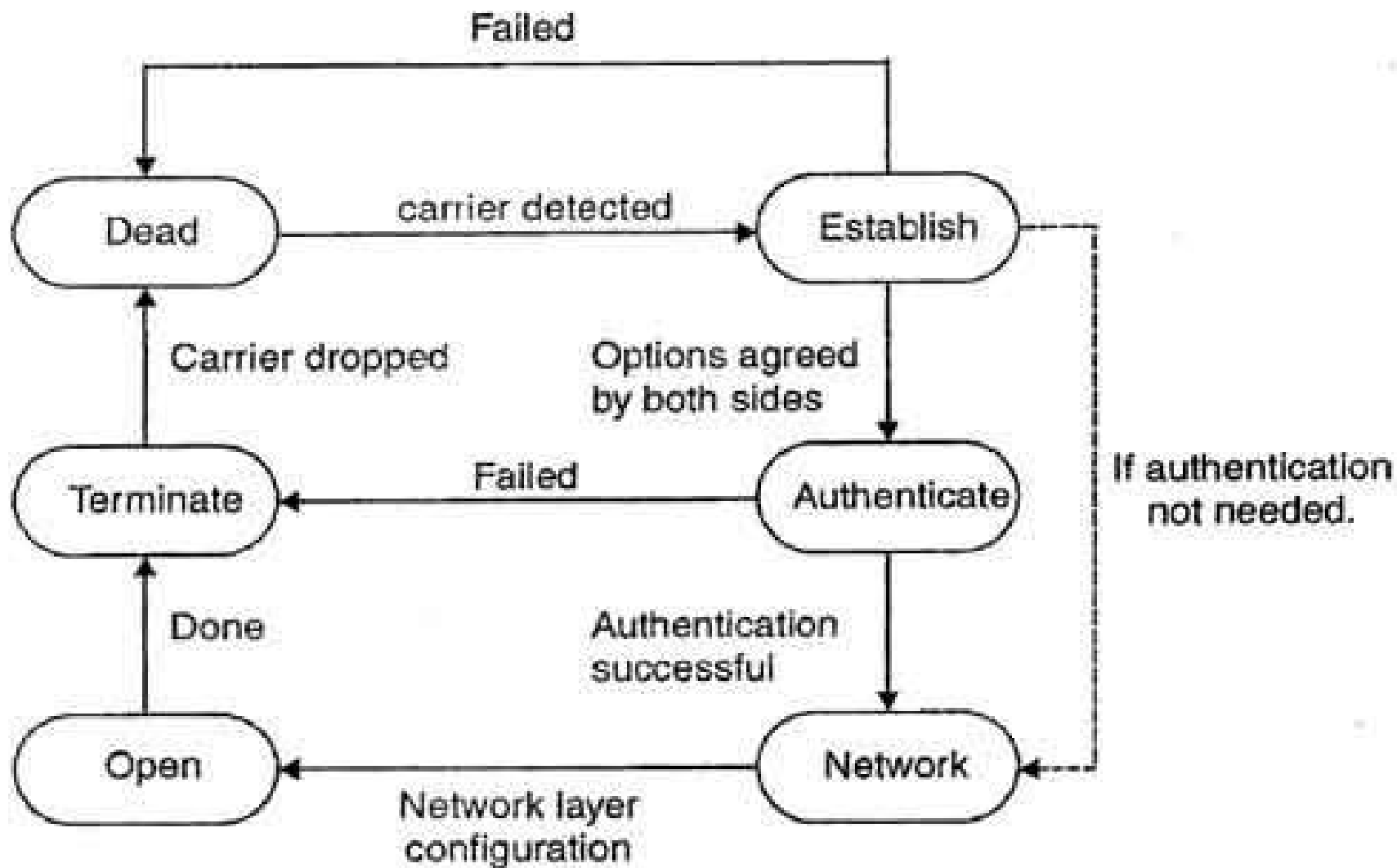

Transition phases

- **Open** : In this phase, actual transfer of data packets takes place. Once transfer is done ,it enters into terminate phase. This is done by exchange of packets and terminates the link.
- **Dead**: In this phase, the link is not used.
- **Establish** : It enter in this phase and begins by making physical connection with the help of Link Control Protocol.(LCP).
- **Authenticate** : PAP (Password Authentication Protocol) will authenticate the sender and receiver by setting the password

- **Terminate** : Once data transfer is complete ,connection should be terminated.
- **Network** : The configuration of Network connection by using Network Connection Protocol(NCP).

High level data link protocols(HDLC)

- HDLC is a bit-oriented protocol.
- HDLC is used for communication over point-to-point and multi-point links.

Transfer modes of HDLC

- HDLC provides two common transfer modes that can be used in a number of different configurations.
 1. Normal Response Mode (NRM)
 2. Asynchronous Balanced Mode (ABM)

Normal Response Mode(NRM)

- In this mode, Primary station sends the commands as request and secondary station can only respond.
- This type of mode can be used for point-to-point and multi-point links.

Asynchronous Balanced mode

- This type of mode is used only for point-to-point link.
- Each station can function as primary and secondary.

11-6 HDLC

High-level Data Link Control (HDLC) is a bit-oriented protocol for communication over point-to-point and multipoint links. It implements the ARQ mechanisms

Configuration and Transfer Modes



a. Point-to-point

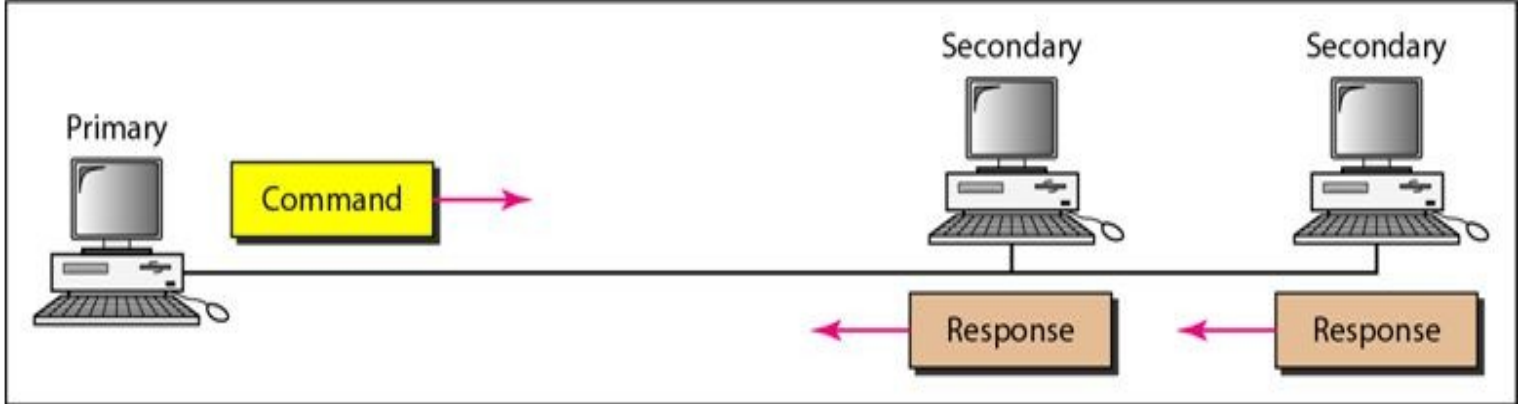

b. Multipoint

Figure 11.26 Asynchronous balanced mode

Figure 11.25 Normal response mode

HDLC Frame Format

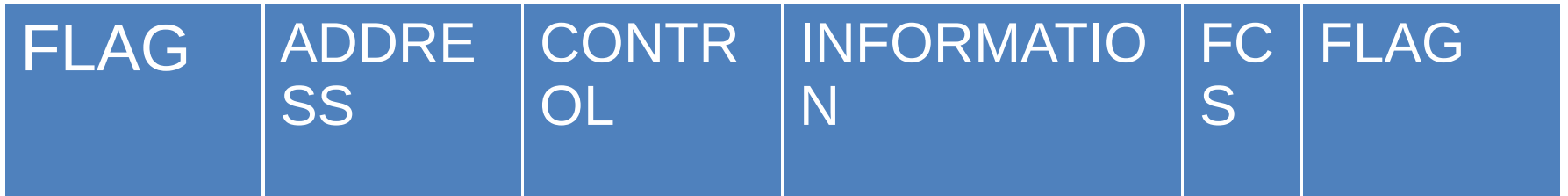

- **Flag field** : This flag field is a 8 bit sequence which indicates beginning and ending of the frame.
- **Address field** : This field contains the address of the secondary station.
- **Control field** : The control field is used for flow and error control.
- **Information field**: The information field contains the user's data from the network.
- **FCS field**: The frame check sequence is the HDLC error detection field.

Types of frames in HDLC

- **Information frame** : They are used to transport user data.
- **Supervisory frame** : They are used only to transport control information. This control information consists of sequence no and acknowledgement no.
- **Unnumbered frame**: They are used when the connection is established and connection is terminated.